

Ultimag[®] Rotary Actuators

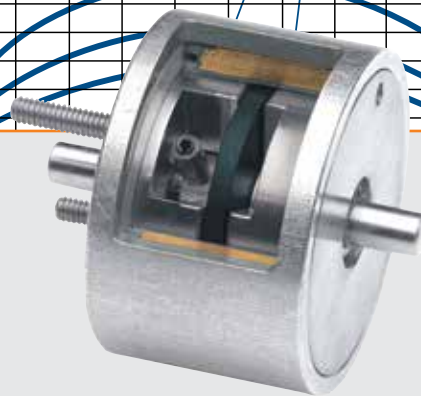

WARNING: Exposed Magnet may affect pacemakers. In the event a product unit's magnet is exposed due to product disassembly, Pacemaker Wearers should distance themselves 3 metres from exposed magnet.

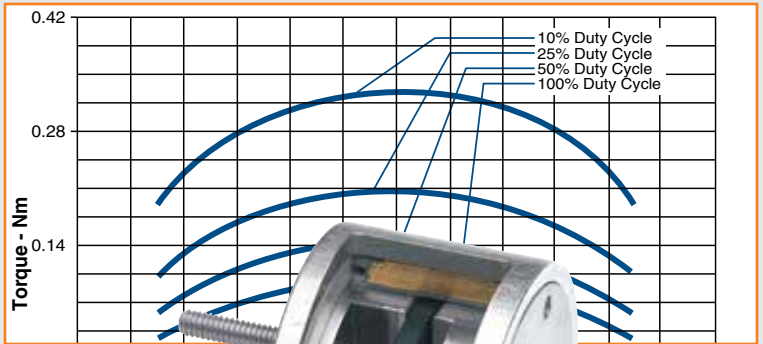

Ultimag® Rotary Actuators

ROTARY Ultimag®



- Speeds over 100 Hz
- Peak torque of over 1.5 Nm
- 100 million actuation life
- Three standard sizes



All catalogue products manufactured after April 1, 2006 are RoHS Compliant

Ultimag® Principle of Operation

Ultimag® operates on the simple principle of attraction and repulsion of opposite and like magnetic poles. The permanent magnetic armature has twice as many poles as the stator. In the de-energised state, the armature poles each share half a stator pole, causing the shaft to seek mid-stroke. When power is applied, the

stator poles are polarised. This attracts half and repels the other half of the armature poles, causing the shaft to rotate. When the voltage is reversed, the stator poles are polarised with the opposite pole. Consequently, the opposite poles of the armature are attracted and repelled, thus causing rotation in the opposite direction.

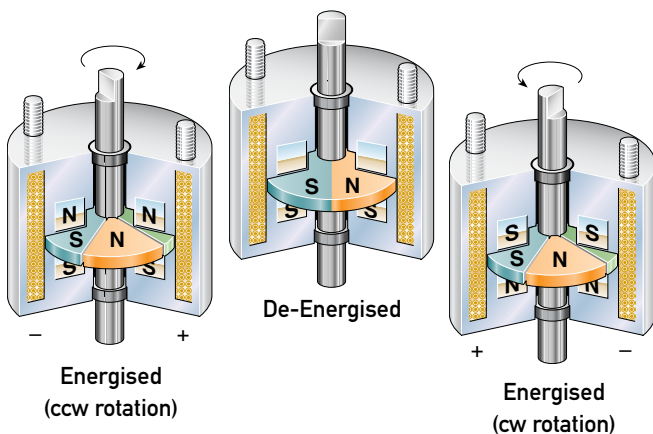

The Ultimag Series has been developed in response to application needs for higher speed and higher torque motion control components. We have found that many applications require a working stroke less than 360°, yet still employ motors with their associated complex and expensive controls and linkages. As a result, a powerful, extremely fast short stroke actuator has many design advantages for industrial, office automation, automotive and medical applications.

We have been designing and manufacturing world class, innovative motion control components for over 60 years. Our patented Ultimag series is the latest of our state-of-the-art developments in rotary actuation products.

Ultimag® Rotary Actuators

The Ultimag® Difference

Ultimag® offers a bidirectional, centre return function not found in rotary solenoids. The Ultimag is substantially faster than other solenoids, and can be operated in an on/off mode or proportionally, in both open loop and closed loop systems.

The Ultimag does not offer 360° of rotation which is definitive of motors. With this stroke limitation in mind, Ultimag provides an inexpensive alternative for limited stroke applications, particularly, when total cost of system control is included.

Ultimag actuators offer a 45° stroke. However, the design is capable of a maximum stroke of 160°. Gears, belts, pulley, etc., can be employed to amplify stroke. In all cases, an increase in stroke will cause a reduction in torque.

For shorter strokes, electronic or mechanical stops can be used. By having a unit tooled to perform a specific stroke less than 45°, more torque will be obtained.

When adding the Ultimag to your application, the shaft must be supported to avoid stress fractures to the magnet.

Temperature Limitation

The permanent magnet in the Ultimag is NdFeB. For applications running above 130°C, we do not recommend the Ultimag, since the NdFeB magnets irreversibly degrade after reaching a 150°C temperature.

Typical Examples of Custom Features

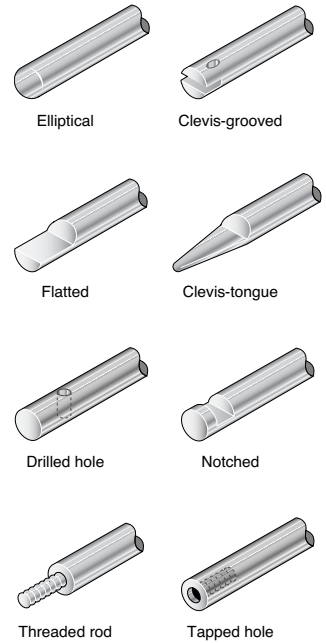

ROTARY Ultimag®

Ultimag Selection Overview

Size	Package Dimensions (mm)		Net Starting Torque (Nm) @ Specified Duty Cycle*				Net Ending Torque (Nm) @ Specified Duty Cycle*			
	Dia.	Length	100%	50%	25%	10%	100%	50%	25%	10%
4EM	41	26	0.10	0.15	0.20	0.33	0.02	0.06	0.10	0.19
5EM	49	32	0.23	0.33	0.44	0.71	0.01	0.08	0.16	0.32
6EM	59	41	0.57	0.80	1.13	1.63	0.28	0.43	0.60	0.85

*Note: Torque outputs degrade with elevated temperatures.

How to Use Ultimag Performance Charts

- Select one of the four columns which provides the appropriate duty cycle. (For example 50%.)
- Reading down this column provides a variety of performance and electrical data including maximum on time, watts, and amp turns.
- Following down the column further into the VDC ratings, select the voltage which most closely matches your supply voltage. (For example, 11.5 for a 12 VDC power supply.)
- Read across (to the left) to select the avg suffix to complete the part number when ordering. (In this example using our 5EM chart, 25 avg is required, thus to order, specify: 199173-025.)

Performance

Maximum Duty Cycle*	100%	50%	25%	10%
K_M (mNm/ $\sqrt{\text{watt}}$)	76.3	84.6	57.4	48.3
Maximum ON Time (sec) when pulsed continuously ¹	∞	40	15	4
Maximum ON Time (sec) for single pulse ²	∞	109	36	10
Typical Energise Time (msec) ³	6.0	5.5	4.5	4.0
Watts (@ 20°C)	2.1	42	84	210
Ampere Turns (@ 20°C)	621	878	1242	1964

Coil Data

avg (0XX) ⁴	Resistance (@20°C)	# Turns ⁵	VDC (Nom)	VDC (Nom)	VDC (Nom)	VDC (Nom)
23	1.05	128	4.7	6.6	9.4	14.8
24	2.24	213	6.9	9.7	13.7	21.7
25	3.16	240	8.1	11.5	16.3	25.8
26	4.45	270	9.7	13.7	19.3	30.6
27	8.50	404	13.4	18.9	26.7	42.2
28	11.90	452	15.8	22.3	31.6	50.0
29	21.10	630	21.0	29.7	42.1	67.0
30	29.50	705	24.9	35.2	49.8	78.7
31	50.30	948	32.5	45.9	65.0	103.0
32	82.70	1232	41.7	58.9	83.0	132.0
33	134.00	1576	53.0	74.9	106.0	168.0

Ultimag® Size 4EM

Part Number: 199172-0XX

All catalogue products manufactured after April 1, 2006 are RoHS Compliant

Specifications

Dielectric Strength	1000 VRMS (23 awg); 1200 VRMS (24-33 awg)
Recommended Minimum Heat Sink	Maximum watts dissipated by the Ultimag are based on an unrestricted flow of air at 20°C, with the Ultimag mounted on the equivalent of an aluminium plate measuring 15.9 cm square x 0.32 cm thick
Thermal Resistance	7.6°C/watt with heatsink; 15.0°C/watt without heatsink
Rotor Inertia	8.43 x 10 ⁻⁷ kgm ²
Peak Torque Rating (Tp)	0.32 Nm
Power Input	145 watts (stalled at Tp; 25°C; Pp)
Number of Phases	1
Static Friction (Tf)	7 mNm
-3dB Closed Loop	78 Hz
Maximum Winding	180°C
Number of Poles	6
Weight:	215 gms
Dimensions:	Ø41.66 mm x 26.3 mm L (See page B10)



Performance

Maximum Duty Cycle	100%	50%	25%	10%
K _m (mNm/√watt)	40.6	35.7	32.2	30.1
Maximum ON Time (sec) when pulsed continuously ¹	∞	40	15	4
Maximum ON Time (sec) for single pulse ²	∞	108	34	9
Typical Energise Time (msec) ³	6	5	4.5	3.5
Watts (@ 20°C)	14.5	29	58	145
Ampere Turns (@ 20°C)	510	721	1020	1613

Coil Data

awg (0XX) ⁴	Resistance (@20°C)	# Turns ⁵	VDC (Nom)	VDC (Nom)	VDC (Nom)	VDC (Nom)
23	0.71	104	3.2	4.5	6.4	10.1
24	1.54	174	4.7	6.7	9.4	14.9
25	2.15	195	5.6	7.9	11.2	17.6
26	3.01	219	6.6	9.3	13.2	20.9
27	5.78	328	9.2	12.9	18.3	28.9
28	8.09	368	10.8	15.3	21.7	34.3
29	14.40	515	14.5	20.4	28.9	45.7
30	20.11	575	18.9	24.2	37.7	59.6
31	34.40	774	22.3	31.6	44.6	71.0
32	56.60	1008	28.7	40.5	57.0	91.0
33	91.40	1288	36.0	51.5	73.0	115.0

How to Order

Add the coil awg number (0XX) to the part number (for example: to order a 25% duty cycle rated at 18.5 VDC, specify 199172-027).

Please see www.ledex.com (click on Stock Products tab) for our list of stock products available through our distributors.

¹ Continuously pulsed at stated watts and duty cycle

² Single pulse at stated watts (with coil at ambient room temperature 20°C)

³ Typical energise time based on no load condition. Times shown are for half of full rotary stroke starting at centre-off position.

⁴ Other coil awg sizes available — please consult factory

⁵ Reference number of turns

WARNING: Exposed Magnet may affect pacemakers. In the event a product unit's magnet is exposed due to product disassembly, Pacemaker Wearers should distance themselves 3 metres from exposed magnet.

All specifications subject to change without notice.

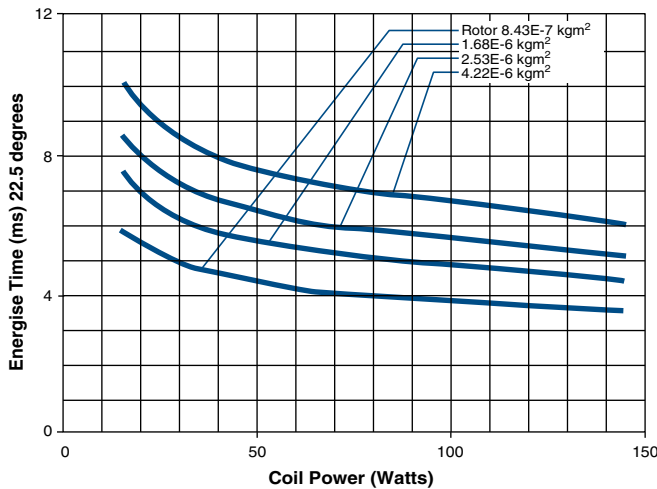
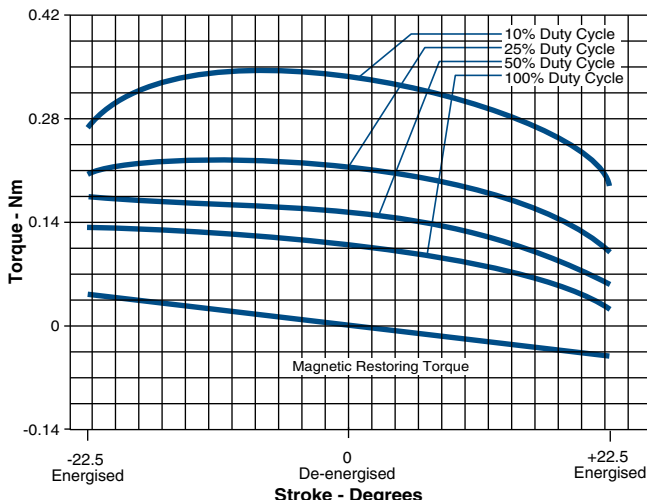
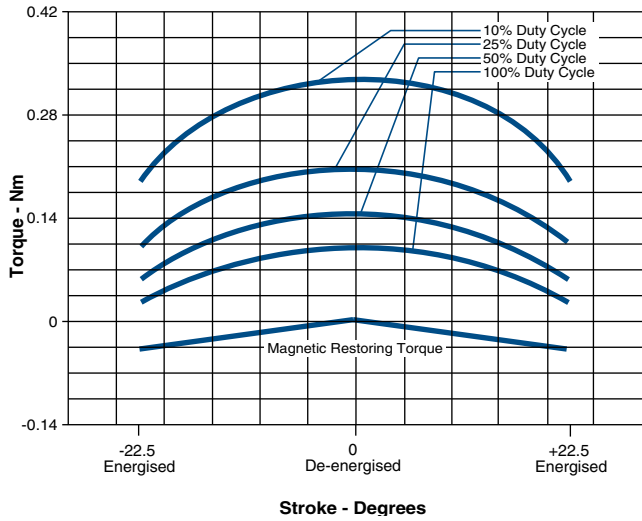

Torque values for reference only.

All specifications subject to change without notice.

Ultimag® Size 5EM

Part Number: 199173-0XX

All catalogue products manufactured after April 1, 2006 are RoHS Compliant

Specifications

Dielectric Strength	1000 VRMS (23 awg); 1200 VRMS (24-33 awg)
Recommended Minimum Heat Sink	Maximum watts dissipated by the Ultimag are based on an unrestricted flow of air at 20°C, with the Ultimag mounted on the equivalent of an aluminium plate measuring 19.1 cm square x 0.32 cm thick
Thermal Resistance	5.36°C/watt with heatsink; 12.9°C/watt without heatsink
Rotor Inertia	3.085 x 10 ⁻⁶ kgm ²
Peak Torque Rating (Tp)	0.7 Nm
Power Input	210 watts (stalled at Tp; 25°C; Pp)
Number of Phases	1
Static Friction (Tf)	7 mNm
-3dB Closed Loop	66.5 Hz
Maximum Winding	180°C
Number of Poles	6
Weight:	363 gms
Dimensions:	Ø49.2 mm x 31.75 mm L max (See page B10)



Performance

Maximum Duty Cycle*	100%	50%	25%	10%
K _M (mNm/√watt)	76.3	84.6	57.4	48.3
Maximum ON Time (sec) when pulsed continuously ¹	∞	40	15	4
Maximum ON Time (sec) for single pulse ²	∞	109	36	10
Typical Energise Time (msec) ³	6.0	5.5	4.5	4.0
Watts (@ 20°C)	21	42	84	210
Ampere Turns (@ 20°C)	621	878	1242	1964

Coil Data

awg (0XX) ⁴	Resistance (@20°C)	# Turns ⁵	VDC (Nom)	VDC (Nom)	VDC (Nom)	VDC (Nom)
23	1.05	128	4.7	6.6	9.4	14.8
24	2.24	213	6.9	9.7	13.7	21.7
25	3.16	240	8.1	11.5	16.3	25.8
26	4.45	270	9.7	13.7	19.3	30.6
27	8.50	404	13.4	18.9	26.7	42.2
28	11.90	452	15.8	22.3	31.6	50.0
29	21.10	630	21.0	29.7	42.1	67.0
30	29.50	705	24.9	35.2	49.8	78.7
31	50.30	948	32.5	45.9	65.0	103.0
32	82.70	1232	41.7	58.9	83.0	132.0
33	134.00	1576	53.0	74.9	106.0	168.0

*Not recommended for full stroke at 100% duty cycle.

How to Order

Add the coil awg number (0XX) to the part number (for example: to order a 25% duty cycle rated at 26.7 VDC, specify 199173-027).

Please see www.ledex.com (click on Stock Products tab) for our list of stock products available through our distributors.

- ¹ Continuously pulsed at stated watts and duty cycle
- ² Single pulse at stated watts (with coil at ambient room temperature 20°C)
- ³ Typical energise time based on no load condition. Times shown are for half of full rotary stroke starting at centre-off position.
- ⁴ Other coil awg sizes available — please consult factory
- ⁵ Reference number of turns

WARNING: Exposed Magnet may affect pacemakers. In the event a product unit's magnet is exposed due to product disassembly, Pacemaker Wearers should distance themselves 3 metres from exposed magnet.

All specifications subject to change without notice.

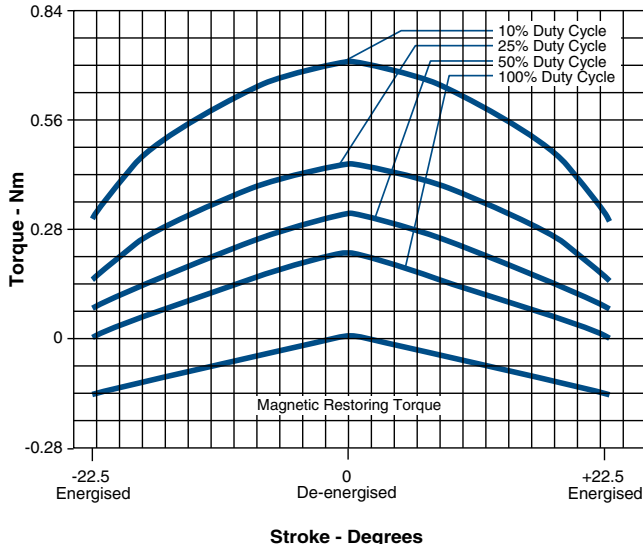

Graph 1 shows three position operation. In any mode, the armature seeks centre of stroke at zero power. Applying a positive or negative voltage causes the shaft to rotate clockwise or counter clockwise. When power is removed, the restoring torque is applied to the load, or alternatively, the shaft can be driven to centre under power.

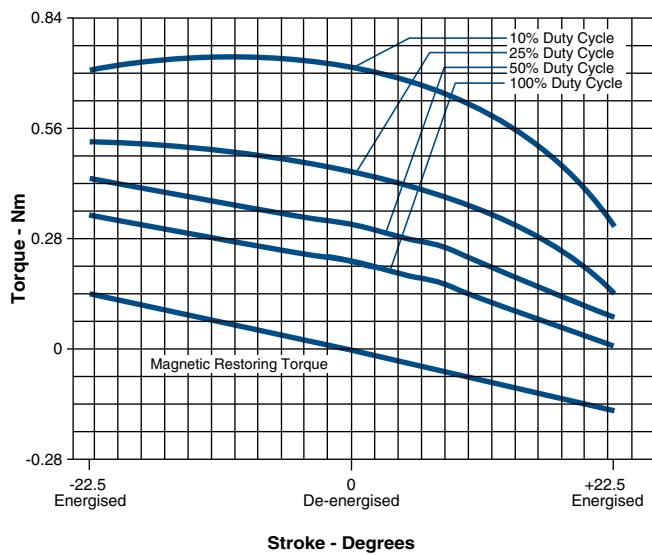

Graph 2 shows operation end-to-end. Note the high starting torque for high starting acceleration or for stopping the load by means of reverse voltage at the end of the stroke. If the device is used in a full stroke application, the load can be externally latched, detented, or biased to either end of stroke.

NOTE: The Size 5EM Ultimag is not recommended for full stroke operation at 100% duty cycle.

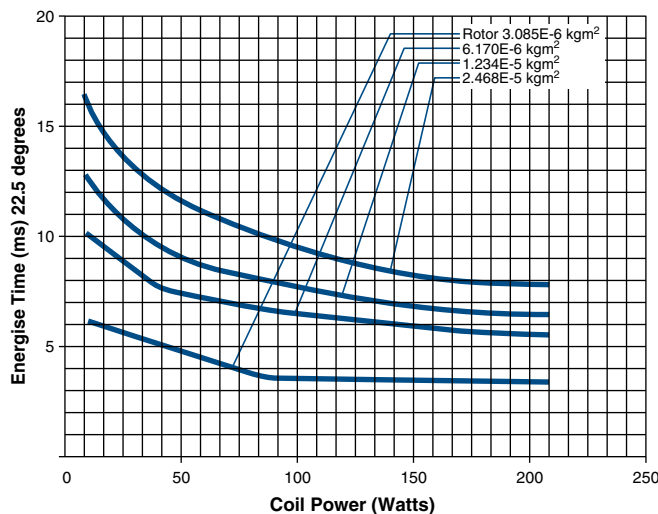

Graph 3 shows how speed varies with load. Each curve represents a different inertial load, which is a multiple of the armature inertia.

Calculate the inertia of your system, then use this chart to determine Ultimag speed in your application. Inertia determination of simple shapes is shown in most engineering handbooks; complex shapes are calculated in solid modeling software or are measured empirically. This graph represents half of the full rotary stroke starting at the centre-off position.

Ultimag® Size 6EM

Part Number: 199174-0XX

All catalogue products manufactured after April 1, 2006 are RoHS Compliant

Specifications

Dielectric Strength	1000 VRMS (23 awg); 1200 VRMS (24-33 awg)
Recommended Minimum Heat Sink	Maximum watts dissipated by the Ultimag are based on an unrestricted flow of air at 20°C, with the Ultimag mounted on the equivalent of an aluminium plate measuring 31.43 cm square x 0.32 cm thick
Thermal Resistance	3.58°C/watt with heatsink; 8.52°C/watt without heatsink
Rotor Inertia	5.676 x 10 ⁻⁶ (kgm ²)
Peak Torque Rating (Tp)	1.6 Nm
Power Input	320 watts (stalled at Tp; 25°C; Pp)
Number of Phases	1
Static Friction (Tf)	7 mNm
-3dB Closed Loop	12.8 Hz
Maximum Winding	180°C
Number of Poles	6
Weight:	0.73 kg
Dimensions:	Ø58.72 mm x 40.6 mm L (See page B10)



Performance

Maximum Duty Cycle	100%	50%	25%	10%
Maximum ON Time (sec) when pulsed continuously ¹	∞	40	15	5
Maximum ON Time (sec) for single pulse ²	∞	143	47	11
Typical Energise Time (msec) ³	17	12	10.5	8.5
Watts (@ 20°C)	32	64	128	320
Ampere Turns (@ 20°C)	980	1386	1960	3100

Coil Data

awg (0XX) ⁴	Resistance (@20°C)	# Turns ⁵	VDC (Nom)	VDC (Nom)	VDC (Nom)	VDC (Nom)
23	2.65	267	9.2	13.0	18.4	29.1
24	5.02	396	12.7	17.9	25.4	40.1
25	7.03	444	15.0	21.2	30.0	47.4
26	12.60	625	20.1	28.4	40.2	63.5
27	17.60	700	23.8	33.6	47.5	75.1
28	29.90	936	30.9	43.7	61.9	97.8
29	49.50	1225	39.8	56.3	80.0	126.0
30	79.70	1560	51.0	71.4	101.0	160.0
31	126.50	1962	64.0	90.0	127.0	201.0
32	198.30	2440	80.0	112.6	159.0	252.0
33	306.20	2992	99.0	140.0	198.0	313.0

How to Order

Add the coil awg number (0XX) to the part number (for example: to order a 25% duty cycle rated at 25.4 VDC, specify 199174-024).

Please see www.ledex.com (click on Stock Products tab) for our list of stock products available through our distributors.

- Continuously pulsed at stated watts and duty cycle
- Single pulse at stated watts (with coil at ambient room temperature 20°C)
- Typical energise time based on no load condition. Times shown are for half of full rotary stroke starting at centre-off position.
- Other coil awg sizes available — please consult factory
- Reference number of turns

WARNING: Exposed Magnet may affect pacemakers. In the event a product unit's magnet is exposed due to product disassembly, Pacemaker Wearers should distance themselves 3 metres from exposed magnet.

All specifications subject to change without notice.

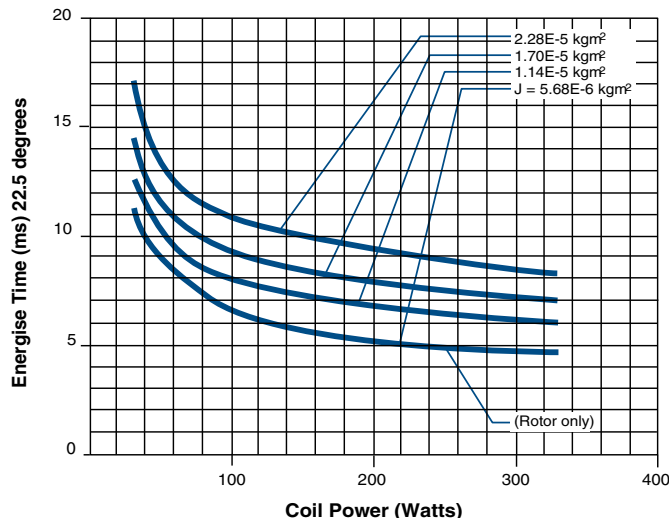
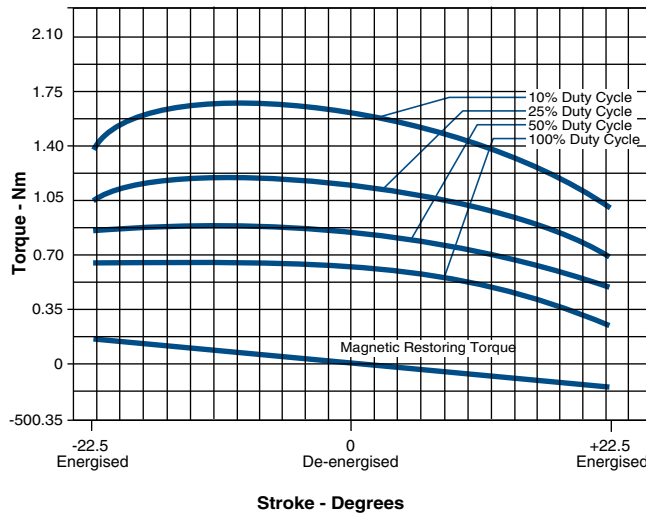
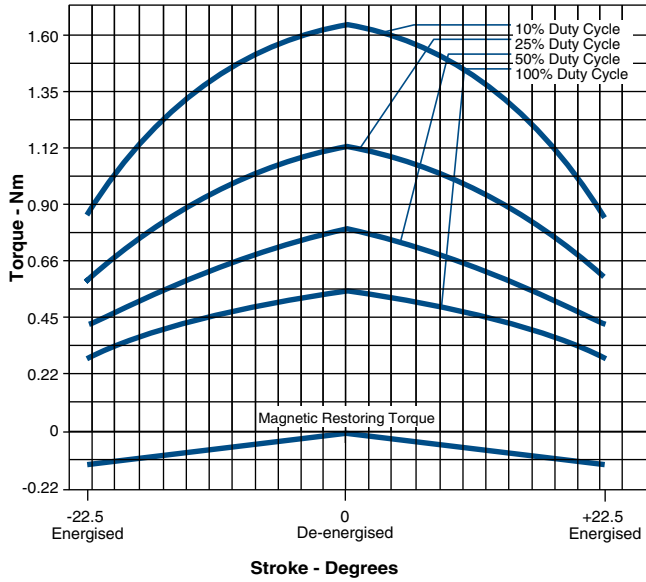

Graph 1 shows three position operation. In any mode, the armature seeks centre of stroke at zero power. Applying a positive or negative voltage causes the shaft to rotate clockwise or counter clockwise. When power is removed, the restoring torque is applied to the load, or alternatively, the shaft can be driven to centre under power.

Graph 2 shows operation end-to-end. Note the high starting torque for high starting acceleration or for stopping the load by means of reverse voltage at the end of the stroke. If the device is used in a full stroke application, the load can be externally latched, detented, or biased to either end of stroke.

Graph 3 shows how speed varies with load. Each curve represents a different inertial load, which is a multiple of the armature inertia.

Calculate the inertia of your system, then use this chart to determine Ultimag speed in your application. Inertia determination of simple shapes is shown in most engineering handbooks; complex shapes are calculated in solid modeling software or are measured empirically. This graph represents half of the full rotary stroke starting at the centre-off position.

Ultimag® Dimensions

ROTARY Ultimag®

mm

4EM

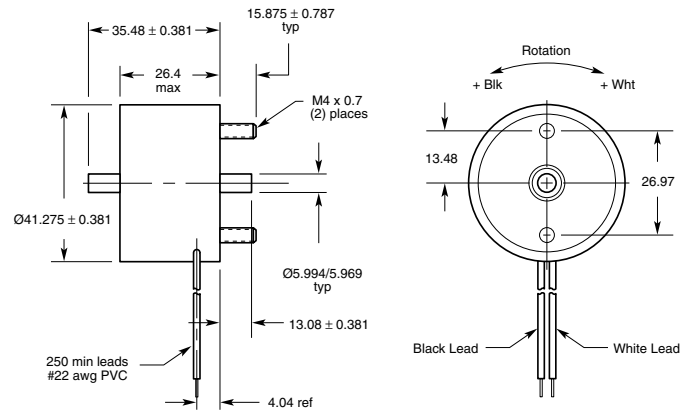

5EM

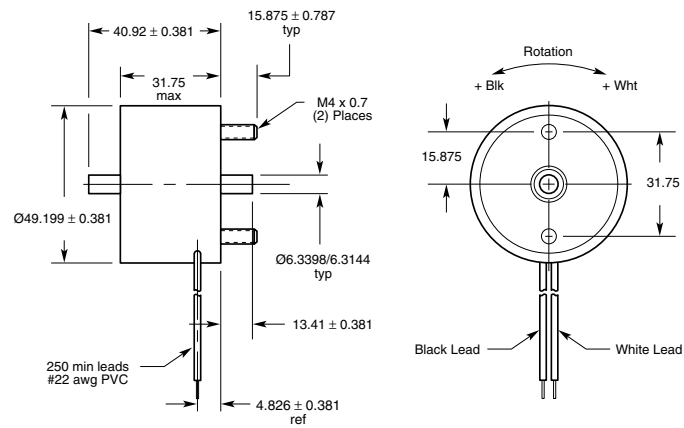

6EM

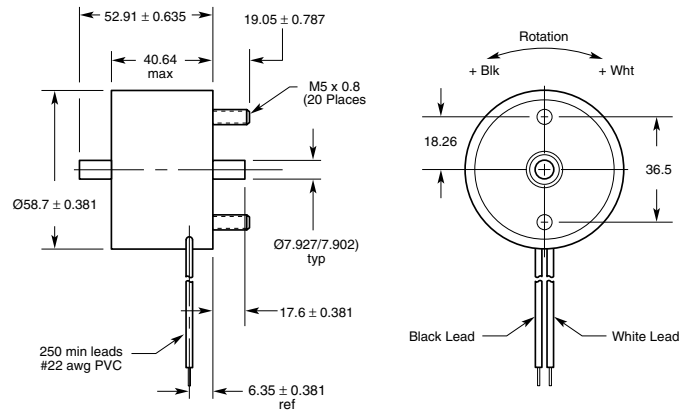

All specifications subject to change without notice.